

 **DATALOGIC**

# Heron™ HD3430 2D Area Imager



**Quick Reference Guide**

## **Datalogic USA, Inc.**

959 Terry Street  
Eugene, OR 97402  
USA

Telephone: (541) 683-5700

Fax: (541) 345-7140

### **©2015-2017 Datalogic S.p.A. and/or its affiliates**

♦ All rights reserved. ♦ Without limiting the rights under copyright, no part of this documentation may be reproduced, stored in or introduced into a retrieval system, or transmitted in any form or by any means, or for any purpose, without the express written permission of Datalogic S.p.A. and/or its affiliates.

Owners of Datalogic products are hereby granted a non-exclusive, revocable license to reproduce and transmit this documentation for the purchaser's own internal business purposes. Purchaser shall not remove or alter any proprietary notices, including copyright notices, contained in this documentation and shall ensure that all notices appear on any reproductions of the documentation.

Should future revisions of this manual be published, you can acquire printed versions by contacting your Datalogic representative. Electronic versions may either be downloadable from the Datalogic website ([www.datalogic.com](http://www.datalogic.com)) or provided on appropriate media. If you visit our website and would like to make comments or suggestions about this or other Datalogic publications, please let us know via the "Contact Datalogic" page.

### **Disclaimer**

Datalogic has taken reasonable measures to provide information in this manual that is complete and accurate, however, Datalogic reserves the right to change any specification at any time without prior notice.

Datalogic and the Datalogic logo are registered trademarks of Datalogic S.p.A. in many countries, including the U.S.A. and the E.U. Heron is a trademark of Datalogic S.p.A. and/or its affiliates, registered in the U.S. All other brand and product names may be trademarks of their respective owners.

### **Patents**

See [www.patents.datalogic.com](http://www.patents.datalogic.com) for patent list.

**See the Regulatory Addendum included with your product for additional regulatory, safety and legal information.**



# Table of Contents

(EULA) FOR THE HERON™ HD3430 .....	iii
Software Product Policy .....	vii
Using the Heron™ Series Readers .....	1
Setting Up the Reader .....	2
Connecting to the Host Interface .....	2
Disconnecting the Cable .....	2
Stand Installation .....	3
Insertion Into Stand .....	4
Adjusting the Stand Position .....	4
To adjust the stand: .....	5
Using the Heron HD3430 Imager .....	6
Selecting the Interface Type .....	7
Interface Selection .....	7
Configuring the Interface.....	8
Keyboard Interface.....	10
Scancode Tables .....	11
Country Mode .....	11
Programming .....	16
Using Programming Bar Codes .....	16
Configure Other Settings .....	16
Resetting Product Defaults .....	16
Audio Jingle .....	17
RGB LED Settings .....	18
Numlock .....	20
Caps Lock State .....	21
Reading Parameters .....	22
Aiming System .....	22
Good Read Green Spot Duration .....	22
Operating Modes .....	23
Scan Mode .....	23
Pick Mode .....	25
Multiple Label Reading .....	25
Technical Features .....	26
LED and Beeper Indications .....	28
Troubleshooting .....	29
Datalogic Limited Factory Warranty .....	30
Ergonomic Recommendations .....	32
Support Through the Website .....	32
Cleaning .....	33
Stand Dimensions .....	34
Stand Base Plate Template .....	35



# DATALOGIC IP TECH S.R.L.

## END USER SOFTWARE LICENSE AGREEMENT (EULA) FOR THE HERON™ HD3430

Notice to End User: There are two types of software covered by this END USER LICENSE AGREEMENT ("EULA"): (1) The Datalogic Product you have acquired contains embedded software ("Embedded Software") which is integral to the Product's operation; and (2) Optional Application Software provided to you on an optional basis ("Application Software"). Embedded Software and Application Software are collectively referred to as "Software" and are subject to the terms and conditions contained in this EULA. Software is provided only for use with, and for authorized end users of, the Datalogic Heron™ HD3430 ("Product"). Portions of the Embedded Software include or operate with Open Source software or libraries ("Open Source"). Use of Open Source is subject to the Open Source licenses available at the following website: <http://www.datalogic.com/oss>.

This EULA (End User Software License Agreement) ("EULA" or "Agreement") is a legally binding agreement governing the licensing of the Software and Documentation by Datalogic IP Tech S.r.l. and its subsidiaries and affiliates ("Datalogic") to the entity or person who has purchased or otherwise acquired a Datalogic Product ("End User"). For purposes of this Agreement, any software that is not Embedded Software or Application Software is software associated with a separate end-user license agreement to you under the terms of that license agreement. Datalogic and End User hereby agree as follows:

### 1. Definitions

- 1.1 "Affiliate" means a business entity currently existing or later acquired that is controlled by, or is under common control with Datalogic S.p.A.
- 1.2 "Documentation" means materials such as user's guides, program reference guides, quick reference guides, manuals, or similar materials associated with or related to the Datalogic Product, whether in printed, "online", or other form.
- 1.3 "Proprietary Information" means: (a) source code, object code, software, documentation, and any related internal design, system design, data base design, algorithms, technology, technical data or information, implementation techniques, and trade secrets related to the Software, (b) any other trade secrets marked appropriately or identified as proprietary or confidential, and (c) any information that End User, under the circumstances, should recognize as confidential. Proprietary Information does not include any information that the receiving party can establish was (1) in the public domain, (2) already in the receiving party's possession or rightfully known prior to receipt, (3) rightfully learned from a third party not in violation of any other's proprietary rights, or (4) independently developed without access to Proprietary Information.
- 1.4 "Datalogic Product" means the Datalogic Heron™ series scanner product, including all embedded Software in and all Documentation related to such product, which has been purchased or otherwise acquired by End User, whether obtained directly or indirectly from Datalogic.
- 1.5 "Software" means any software or computer programs of Datalogic or its third party licensors in machine readable form which is embedded in the Datalogic Product, whether obtained directly or indirectly from Datalogic, including any replacement, update, upgrade, enhancement or modification.

### 2. Scope Of License Granted

- 2.1 Datalogic grants to End User a personal non-exclusive, non-transferable, perpetual license to use the Software, solely on the Datalogic Product in which it is embedded ("designated Datalogic Product"), in machine-readable form only, solely for End User's internal business purposes. This Agreement does not convey ownership of the Software to End User. Title to the Software shall be and remain with Datalogic or the third party from whom Datalogic has obtained a licensed right. As used in this Agreement, the term "purchase" or its equivalents when applied to the Software shall mean "acquire under license." End User is not entitled to receipt or use of the source code to any Software.
- 2.2 End User shall not copy, modify, decompile, disassemble, reverse engineer, or otherwise reproduce or remanufacture the Software, whether modified or unmodified, nor sell, assign, sublicense, distribute, lend, rent, give, or otherwise transfer the Software to any other person or organization, for purposes other than as expressly provided in this Agreement, without Datalogic's prior written consent.

### 3. Transfers, Support

- 3.1 Any copying, installing, reproduction, remanufacture, reverse engineering, electronic transfer, or other use of the Software on other than the designated Datalogic Product

will be a material breach of this Agreement. However, Datalogic may elect not to terminate this Agreement or the granted licenses, but instead may elect to notify End User that End User is deemed to have ordered and accepted a license for each breaching use. End User shall pay Datalogic the applicable list price for such licenses as of the date of such breach.

- 3.2 End User shall not sell, assign, sublicense, distribute, lend, rent, give, or otherwise transfer the Datalogic Product to any third party unless such third party agrees with Datalogic in writing to be bound by the terms and conditions of this Agreement. Any such transfer of the Datalogic Product absent such agreement shall be null and void.
- 3.3 End User may obtain support for Software from Datalogic at Datalogic's standard support fees and under Datalogic's standard support terms and conditions in effect at the time the support is requested.

#### **4. Intellectual Property**

End User acknowledges that the Software comprises valuable trade secrets of Datalogic or Datalogic's third party licensors and that the Software is protected by United States copyright law and trade secret law, and by all applicable international intellectual property laws and treaty provisions. The license set forth in this Agreement does not transfer to End User any ownership of Datalogic's or its third party licensors' copyrights, patents, trademarks, service marks, trade secrets, or other intellectual property rights and End User shall have no right to commence any legal actions to obtain such rights. End User shall not remove, modify, or take any other action that would obscure any copyright, trademark, patent marking, or other intellectual property notices contained in or on the Datalogic Product.

#### **5. Proprietary Information**

- 5.1 End User acknowledges that Proprietary Information is the confidential, proprietary, and trade secret property of Datalogic and Datalogic's third party licensors and End User acquires no right or interest in any Proprietary Information.
- 5.2 End User shall not disclose, provide, or otherwise make available the Proprietary Information of Datalogic or its third party licensors to any person other than End User's authorized employees or agents who are under confidentiality agreement, and End User shall not use the Proprietary Information other than in conjunction with use of the Datalogic Product exclusively for End User's internal business purposes. End User shall take steps to protect the Proprietary Information no less securely than if it were End User's own intellectual property.
- 5.3 The provisions of this Proprietary Information Section shall survive and continue for five (5) years after the termination of this Agreement.

#### **6. Limited Warranty**

- 6.1 Datalogic warrants that, under normal use and operation, the Datalogic Product will conform substantially to the applicable Documentation for the period specified in the Documentation. During this period, for all reproducible nonconformities for which Datalogic has been given written notice, Datalogic will use commercially reasonable efforts to remedy nonconformities verified by Datalogic. End User agrees to supply Datalogic with all reasonably requested information and assistance necessary to help Datalogic in remedying such nonconformities. For all defects reported to Datalogic within the warranty period, Datalogic's liability is limited to providing End User with one copy of corrections or responding to End User's problem reports according to Datalogic's standard assistance practices. Datalogic does not warrant that the product will meet End User's requirements or that use of the product will be uninterrupted or error free, or that Datalogic's remedial efforts will correct any nonconformance. This limited warranty does not cover any product that have been subjected to damage or abuse, whether intentionally, accidentally, or by neglect, or to unauthorized repair or unauthorized installation, and shall be void if End User modifies the product, uses the product in any manner other than as established in the Documentation, or if End User breaches any of the provisions of this Agreement.
- 6.2 EXCEPT AS PROVIDED IN THIS AGREEMENT, THE DATALOGIC PRODUCT IS PROVIDED "AS IS" AND DATALOGIC MAKES NO WARRANTIES OF ANY KIND, EXPRESS OR IMPLIED, WRITTEN OR ORAL, WITH RESPECT TO THE PRODUCT, AND SPECIFICALLY DISCLAIMS THE IMPLIED WARRANTIES OF MERCHANTABILITY AND FITNESS FOR A PARTICULAR PURPOSE.

#### **7. Infringement**

To the maximum extent permitted by law, End User agrees to defend, indemnify and hold harmless Datalogic, its affiliates and their respective directors, officers, employees and agents from and against any and all claims, actions, suits or proceedings, as well as any and all losses, liabilities, damages, costs and expenses (including reasonable attorney's fees) arising out of or accruing from (a) the End User's use of Software, (b) any application the End User develops on the Software that infringes any Intellectual Property Rights of any person or defames any person or

violates their rights of publicity or privacy, and (c) any non-compliance by the End User of this Agreement.

## 8. Limitation Of Liability

DATALOGIC SHALL NOT BE LIABLE FOR ANY CLAIMS AGAINST END USER BY ANY OTHER PARTY. IN NO EVENT SHALL DATALOGIC'S LIABILITY FOR DAMAGES, IF ANY, WHETHER BASED UPON CONTRACT, TORT (INCLUDING NEGLIGENCE), PRODUCT LIABILITY, STRICT LIABILITY, WARRANTY, OR ANY OTHER BASIS, EXCEED THE PRICE OR FEE PAID BY END USER FOR THE DATALOGIC PRODUCT. UNDER NO CIRCUMSTANCES SHALL DATALOGIC BE LIABLE TO END USER OR ANY THIRD PARTY FOR LOST PROFITS, LOST DATA, INTERRUPTION OF BUSINESS OR SERVICE, OR FOR ANY OTHER SPECIAL, CONSEQUENTIAL, CONTINGENT, INDIRECT, INCIDENTAL, PUNITIVE, EXEMPLARY, OR OTHER SIMILAR DAMAGES, EVEN IF DATALOGIC HAS BEEN ADVISED OF THE POSSIBILITY OF SUCH DAMAGES.

## 9. Government Restricted Rights; International Use

- 9.1 Use, duplication, or disclosure of the Software by the U.S. Government is subject to the restrictions for computer software developed at private expense as set forth in the U.S. Federal Acquisition Regulations at FAR 52.227-14(g), or 52.227-19 or in the Rights in Technical Data and Computer Software clause at DFARS 252.227-7013(c)(1)(ii), whichever is applicable.
- 9.2 If End User is using the Datalogic Product outside of the United States, End User must comply with the applicable local laws of the country in which the Datalogic Product is used, with U.S. export control laws, and with the English language version of this Agreement. The provisions of the "United Nations Convention on International Sale of Goods" shall not apply to this Agreement.

## 10. Termination

- 10.1 Either party may terminate this Agreement or any license granted under this Agreement at any time upon written notice if the other party breaches any provision of this Agreement.
- 10.2 Upon termination of this Agreement, End User immediately shall cease using any nonembedded software and shall return to Datalogic or destroy all nonembedded software covered by this Agreement, and shall furnish Datalogic with a certificate of compliance with this provision signed by an officer or authorized representative of End User. For embedded software, End User agrees to sign a waiver prepared by Datalogic concerning further use of the embedded Software. End User's resumed or continued use of the embedded Software after termination shall constitute End User's agreement to be bound by the terms and conditions of this Agreement for such use.

## 11. General Provisions

- 11.1 Entire Agreement; Amendment. This document contains the entire agreement between the parties relating to the licensing of the Software and supersedes all prior or contemporaneous agreements, written or oral, between the parties concerning the licensing of the Software. This Agreement may not be changed, amended, or modified except by written document signed by Datalogic.
- 11.2 Notice. All notices required or authorized under this Agreement shall be given in writing, and shall be effective when received, with evidence of receipt. Notices to Datalogic shall be sent to the attention of Datalogic IP Tech S.r.l., Legal & IP Department, Via San Vitalino 13, 40012 Calderara di Reno (Bologna), Italy or such other address as may be specified by Datalogic in writing.
- 11.3 Waiver. A party's failure to enforce any of the terms and conditions of this Agreement shall not prevent the party's later enforcement of such terms and conditions.
- 11.4 Governing Law; Venue: Both parties agree to the application of the laws of the country in which End User obtained the license to govern, interpret, and enforce all of End User's and Datalogic's respective rights, duties, and obligations arising from, or relating in any manner to, the subject matter of this Agreement, without regard to conflict of law principles. The United Nations Convention on Contracts for the International Sale of Goods does not apply.

All rights, duties, and obligations are subject to the courts of the country in which End User obtained the license. For licenses granted by Licensee who operates in the countries specified below, the following terms applies.

For Americas.

This Agreement is governed by the laws of the State of Oregon. This Agreement and the rights of the parties hereunder shall be governed by and construed in accordance with the laws of the State of Oregon U.S.A, without regard to the rules governing

conflicts of law. The state or federal courts of the State of Oregon located in either Multnomah or Lane counties shall have exclusive jurisdiction over all matters regarding this Agreement, except that Datalogic shall have the right, at its absolute discretion, to initiate proceedings in the courts of any other state, country, or territory in which End User resides, or in which any of End User's assets are located. In the event an action is brought to enforce the terms and conditions of this Agreement, the prevailing party shall be entitled to reasonable attorneys' fees, both at trial and on appeal.

For Europe, Middle East and Africa

This Agreement is governed by the laws of Italy. This Agreement and the rights of the parties hereunder shall be governed by and construed in accordance with the laws of Italy, without regard to the rules governing conflicts of law. Italian Court of Bologna shall have exclusive jurisdiction over all matters regarding this Agreement, except that Datalogic shall have the right, at its absolute discretion, to initiate proceedings in the courts of any other state, country, or territory in which End User resides, or in which any of End User's assets are located. In the event an action is brought to enforce the terms and conditions of this Agreement, the prevailing party shall be entitled to reasonable attorneys' fees, both at trial and on appeal.

For Asia- Pacific Countries

This Agreement is governed by the laws of the State of Hong Kong. This Agreement and the rights of the parties hereunder shall be governed by and construed in accordance with the laws of the State of Hong Kong without regard to the rules governing conflicts of law. The Court of Hong Kong shall have exclusive jurisdiction over all matters regarding this Agreement, except that Datalogic shall have the right, at its absolute discretion, to initiate proceedings in the courts of any other state, country, or territory in which End User resides, or in which any of End User's assets are located. In the event an action is brought to enforce the terms and conditions of this Agreement, the prevailing party shall be entitled to reasonable attorneys' fees, both at trial and on appeal.

11.5 Attorneys' Fees. In the event an action is brought to enforce the terms and conditions of this Agreement, the prevailing party shall be entitled to reasonable attorneys' fees, both at trial and on appeal.

**- END -**



## Software Product Policy

Datalogic reserves the right to ship its products with the latest version of software/firmware available. This provides our customers with the very latest in Datalogic software technology.

The only exception to this policy is when the buyer has a signed contract with Datalogic that clearly defines the terms and conditions for making software/firmware changes in products shipped to the buyer.

To arrange for a Software Maintenance and Support Agreement please contact your Datalogic sales person.

# NOTES



# Heron™ HD3430

## Using the Heron™ Series Readers

The Heron™ HD3430 Linear Imager has several new features:

- the reader's attractive illumination (top and sides) selectively changes color to indicate its status.
- the option to use personal jingles (a short user-defined tune uploaded via Datalogic Aladdin™ configuration software) instead of the normal beep tone.

Heron™ readers automatically scan bar codes **at a distance**. Simply aim and pull the trigger. Code scanning is performed along the center of the light bar emitted from the reading window. This bar must cover the entire code.

Effective scanning is obtained by tilting the scanner with respect to the bar code to avoid direct reflections, which impair the reading performance (see Figure 1A below). A successful read is signaled by an audible tone or a jingle (previously uploaded), plus a good-read green spot. The side and upper illuminators become green (unless another color has been configured with Aladdin configurator).

Once the reader is correctly inserted into the stand, it is immediately ready to automatically read any code present in its reading area without pressing the trigger. Furthermore, a red pattern (central cross and four spots located in corners) is continuously emitted to facilitate the aiming of the bar code to be read (shown in Figure 1B). To guarantee single code reading, consecutive reading of the same code requires the code to be removed from the reading area (no decoding) before the reader will accept the same code again.

**Figure 1. Correct positioning of scanner**

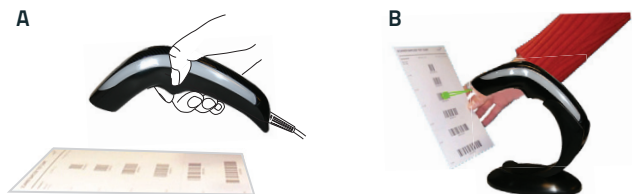

## Setting Up the Reader

Follow the steps below to connect and get your reader up and communicating with its host.

1. Connect the Cable to the reader and the Host as shown below.
2. Configure the Interface (see page 7).
3. Program the Reader starting on page 22 (optional, as needed).

### Connecting to the Host Interface



### Disconnecting the Cable

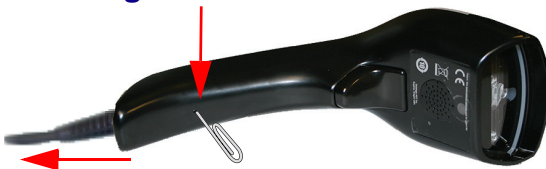

## Stand Installation

The stand can be affixed to a flat surface such as a desk or countertop. If needed, it can also be easily removed.

To install the stand:

1. Remove the protective film from the rubber feet and adhere them to the corresponding recessed areas on the bottom surface of the stand.
2. Use the template mask at the back of this manual to locate the desired position of the stand base on the desk.
3. Use a pen to mark the location of the small holes (shown in red) on the desk surface. Remove the mask before installing the screws.



4. Screw the 2 wood screws into the desk, centering in the marked holes. Leave about 4-5 mm of the screw protruding from the upper surface of the desk.



### NOTE

**On hard surfaces, an electric screwdriver can be used for easier installation of the screws.**

5. Set the stand in place on the screws by aligning the large holes (circled in blue) with the screw heads.

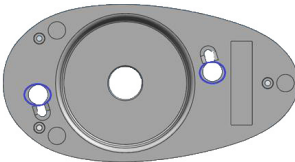

6. Rotate the stand counterclockwise until you feel it lock into place.

7. If the rotation is obstructed, or if the stand does not lock into place, remove the stand and adjust the height of the screws. Retry.
8. To remove the stand, rotate clockwise and lift to detach.

### Insertion Into Stand

Place the reader into the stand, taking care to insert the handle into the stand clip as shown.



Correct insertion will be signaled by a beep; then the reader will be ready to read bar codes.

### Adjusting the Stand Position

The stand can easily be adjusted to change the inclination of the reader while in the stand.

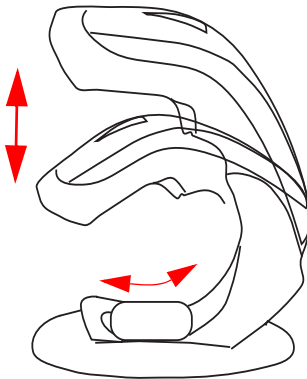

## To adjust the stand:

1. With fingers, loosen the screw on the bottom of the stand by turning it counterclockwise.



2. Set the stand upright and slide to adjust to the desired position.



3. Re-tighten the screw to secure the stand.

## Using the Heron HD3430 Imager

The Heron™ HD34XX normally functions by capturing and decoding codes. The aiming system is activated on trigger pull and indicates the center of the field of view which should be positioned over the bar code:

### Aiming System

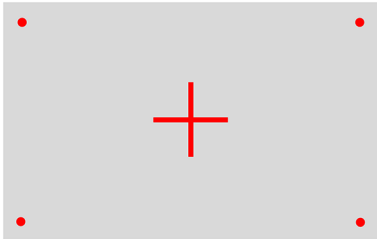

### Relative Size and Location of Aiming System Pattern

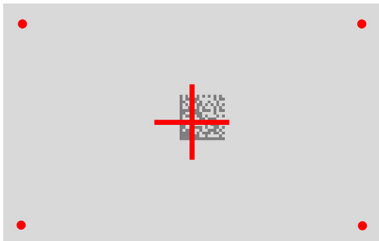

### 2D Matrix symbol

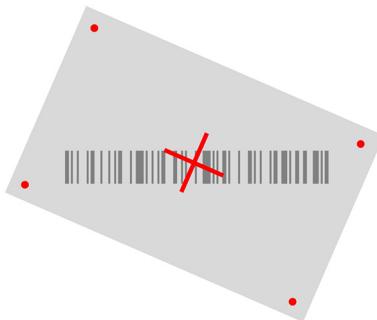

### Linear bar code



A beam illuminates the label. The projected pattern of the aiming system will be smaller when the reader is closer to the bar code and larger when it is farther from the code. Symbologies with smaller bars or elements (mil size) should be read closer to the unit. Symbologies with larger bars or elements (mil size) should be read farther from the unit. If the aiming system is centered you will get a good read. Successful reading is signaled by an audible tone plus a good-read green spot LED indicator.

### Relative Size and Location of Green Spot

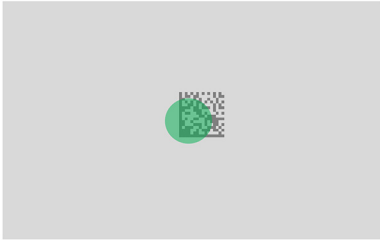

Reference the Heron HD34XX Product Reference Guide (PRG) on the Datalogic website for more information about this feature and other programmable settings.

## Selecting the Interface Type

Upon completing the physical connection between the reader and its host, proceed directly to Interface Selection below for information and programming for the interface type the reader is connected to (RS-232, Keyboard Wedge, USB) and scan the appropriate bar code to select your system's correct interface type, according to your application.

For interfaces other than those listed in this manual, see the Heron HD3430 Product Reference Guide (PRG), available online at [www.datalogic.com](http://www.datalogic.com).

## Interface Selection

The reader model will support all the following host interfaces:

- RS-232
- RS-232 OPOS
- USB (Keyboard, COM, OEM)
- USB Composite (Keyboard + COM)
- Keyboard Wedge.

Information and programming options for each interface type are provided in this section. For defaults and additional information associated with each interface, proceed to the corresponding chapter in the Heron™ HD3430 PRG.

## Configuring the Interface

Scan the appropriate programming bar code to select the interface type for your system.



### NOTE

**Unlike some other programming features and options, interface selections require that you scan only one programming bar code label. DO NOT scan an ENTER/EXIT bar code prior to scanning an interface selection bar code.**

**Some interfaces require the scanner to start in the disabled state when powered up. If additional scanner configuration is desired while in this state, pull the trigger and hold for 5 seconds. The scanner will change to a state that allows programming with bar codes.**

## RS-232

RS-232 standard interface



Select RS232-STD

RS-232 Wincor-Nixdorf



Select RS232-WN

RS-232 for use with OPOS/UPOS/JavaPOS



Select RS-232 OPOS

**RS-232 (continued)**

USB Com to simulate RS-232 standard interface



Select USB-COM-STD<sup>a</sup>

**USB-OEM**

USB-OEM (can be used for OPOS/UPOS/JavaPOS)



Select USB-OEM

a. Download the correct USB Com driver from [www.datalogic.com](http://www.datalogic.com)

**USB-COMPOSITE**

USB-Composite



Select USB-Composite

## Keyboard Interface

Use the programming bar codes to select options for USB Keyboard and Wedge Interfaces.

### KEYBOARD

AT, PS/2 25-286, 30-286, 50, 50Z, 60, 70, 80, 90 & 95 w/  
Standard Key Encoding



Select KBD-AT

Keyboard Wedge for IBM AT PS2 with standard key encoding but without  
external keyboard



Select KBD-AT-NK

AT, PS/2 25-286, 30-286, 50, 50Z, 60, 70, 80, 90 & 95  
w/Alternate Key



Select KBD-AT-ALT

Keyboard Wedge for IBM AT PS2 with alternate key encoding but without  
external keyboard



Select KBD-AT-ALT-NK

**KEYBOARD (continued)**

USB Keyboard with standard key encoding



Select USB Keyboard

USB Keyboard with alternate key encoding



Select USB Alternate Keyboard

## Scancode Tables

Reference the Heron HD34XX PRG for information about control character emulation for keyboard interfaces.

## Country Mode

This feature specifies the country/language supported by the keyboard. Only these interfaces support ALL Country Modes:

- USB Keyboard with alternate key encoding
- USB Keyboard with standard key encoding
- AT, PS/2 25-286, 30-286, 50, 50Z, 60, 70, 80, 90 & 95 w/Std Key Encoding
- Keyboard Wedge for IBM AT PS2 with standard key encoding but without external keyboard
- AT, PS/2 25-286, 30-286, 50, 50Z, 60, 70, 80, 90 & 95 without Alternate Key
- Keyboard Wedge for IBM AT PS2 without alternate key encoding but without external keyboard

All other interfaces support ONLY the following Country Modes: U.S., Belgium, Britain, France, Germany, Italy, Spain, Sweden.

**COUNTRY MODE**



ENTER/EXIT PROGRAMMING MODE



Country Mode = U.S.



Country Mode = Belgium



Country Mode = Croatia\*



Country Mode = Czech Republic\*



Country Mode = Denmark\*

\*Supports only the interfaces listed in the Country Mode feature description

**COUNTRY MODE (continued)**

Country Mode = France



Country Mode = French Canadian\*



Country Mode = Germany



Country Mode = Hungary\*



Country Mode = Italy



Country Mode = Japanese 106-key\*

\*Supports only the interfaces listed in the Country Mode feature description

**COUNTRY MODE (continued)**



Country Mode = Lithuanian\*



Country Mode = Norway\*



Country Mode = Poland\*



Country Mode = Portugal\*



Country Mode = Romania\*



Country Mode = Spain

\*Supports only the interfaces listed in the Country Mode feature description



**COUNTRY MODE (continued)**

Country Mode = Sweden



Country Mode = Slovakia\*



Country Mode = Switzerland\*

\*Supports only the interfaces listed in the Country Mode feature description

# Programming

The reader is factory-configured with a set of standard default features. After scanning the interface bar code from the Interfaces section, select other options and customize your reader through use of the programming bar codes available in the Heron HD34XX PRG. Check the corresponding features section for your interface, and also the Data Editing and Symbologies chapters of the PRG.

## Using Programming Bar Codes

This manual contains bar codes which allow you to reconfigure your reader. Some programming bar code labels, like the "Reset Default Settings" on page 16, require only the scan of that single label to enact the change.

Other bar codes require the reader to be placed in Programming Mode prior to scanning them. Scan an ENTER/EXIT bar code once to enter Programming Mode; scan the desired parameter settings; scan the ENTER/EXIT bar code again to accept your changes, which exits Programming Mode and returns the reader to normal operation.

## Configure Other Settings

Additional programming bar codes are available in the PRG to allow for customizing programming features. If your installation requires different programming than the standard factory default settings, refer to the PRG.

## Resetting Product Defaults

If you aren't sure what programming options are in your reader, or you've changed some options and want your custom factory settings restored, scan the bar code below to reset the reader to its initial configuration. Reference the PRG for other options, and a listing of standard factory settings.



### NOTE

**Factory defaults are based on the interface type. Be sure your reader is configured for the correct interface before scanning this label. See "Selecting the Interface Type" on page 7 for more information.**



Reset Default Settings

## Audio Jingle

Instead of the normal beep, a jingle previously uploaded can be selected as the good read audio indication. To change the settings refer to the Heron™ HD3430 PRG.

### AUDIO JINGLE



Disable Jingle



Enable Jingle

### AUDIO VOLUME



Volume off



Low Volume



Medium Volume



High Volume

## RGB LED Settings

The following configuration items specify settings for the RGB (Red Green Blue) LEDs, which are used to indicate Good Read and Body Illumination when Scanner is in Idle mode.

GOOD READ LED COLOR	
 ENTER/EXIT PROGRAMMING MODE	
 GOOD READ INDICATOR = DISABLE	 ◆GOOD READ INDICATOR = ENABLE
 GOOD READ LED COLOR = RED	 ◆GOOD READ LED COLOR = GREEN
 GOOD READ LED COLOR = BLUE	

## Scanner Idle LED Color



ENTER/EXIT PROGRAMMING MODE



BODY ILLUMINATION = DISABLE



◆ BODY ILLUMINATION = ENABLE



◆ COLOR = SOLID BLUE



COLOR = SOLID YELLOW



COLOR = SOLID RED



COLOR = SOLID PURPLE



COLOR = SOLID GREEN\*



COLOR = RANDOM COLORS



\* In this case a different Color should be chosen for the Good Read LED.

**NOTE**

To define complex patterns, please use Aladdin to set up.

## Numlock

This option specifies the setting of the Numbers Lock (Numlock) key while in keyboard wedge interface. This only applies to alternate key encoding interfaces. It does not apply to USB keyboard.

NUMLOCK
 ENTER/EXIT PROGRAMMING MODE
 Numlock = Numlock key unchanged
 Numlock = Numlock key toggled

## Caps Lock State

This option specifies the format in which the reader sends character data. This applies to keyboard wedge interfaces. This does not apply when an alternate key encoding keyboard is selected.

### CAPS LOCK STATE



ENTER/EXIT PROGRAMMING MODE



Caps Lock State = Caps Lock OFF



Caps Lock State = Caps Lock ON



Caps Lock State = AUTO Caps Lock Enable

## Reading Parameters

Move the reader toward the target and center the aiming pattern and illumination system to capture and decode the image. See [Using the Heron HD3430 Imager on page 6](#) for more information.

The aiming system will briefly switch off after the acquisition time, and if no code is decoded will switch on again before the next acquisition. The illuminator will remain on until the symbol is decoded.





As you read code symbols, adjust the distance at which you are holding the reader.

## Aiming System

A number of options for customizing control of the Aiming System are available. See the Heron HD34XX PRG for more information and programming bar codes.

## Good Read Green Spot Duration

Successful reading can be signaled by a good read green spot. Use the bar codes that follow to specify the duration of the good read pointer beam after a good read.

GOOD READ GREEN SPOT DURATION	
 ENTER/EXIT PROGRAMMING MODE	
 Disabled	 ♦ Short (300 ms)
 Medium (500 ms)	 Long (800 ms)



---

# Operating Modes

## Scan Mode

The imager can be set to operate in one of several scanning modes. See the PRG for more information and settings for any of the options:

**Trigger Single (Default)** — This mode is associated with typical handheld reader operation. When the trigger is pulled, illumination is turned on and the scanner attempts to read a label. Scanning is activated until one of the following occurs:

- the programmable 'maximum scan on time'<sup>1</sup> has elapsed
- a label has been read
- the trigger is released

**Trigger Pulse Multiple** — Scanning begins when the trigger is pulled and continues after the trigger is released, until the trigger is pulled again or until the programmable 'maximum scan on time'<sup>1</sup> has elapsed. Reading a label does not disable scanning. Double Read Timeout<sup>1</sup> prevents undesired multiple reads while in this mode.

**Trigger Hold Multiple** — When the trigger is pulled, scanning starts and the product scans until the trigger is released or 'maximum scan on time'<sup>1</sup> has elapsed. Reading a label does not disable scanning. Double Read Timeout<sup>1</sup> prevents undesired multiple reads while in this mode.

**Always On** — The illuminator is always ON and the reader is always ready for code reading. Double Read Timeout<sup>1</sup> prevents undesired multiple reads.

**Flashing** — The reader illuminator flashes on and off regardless of the trigger status. Code reading takes place only during the Flash On<sup>2</sup> time. Double Read Timeout<sup>1</sup> prevents undesired multiple reads.

**Object Detection** — The scanner looks for changes within its field-of-view. The Aiming Pattern is always on to show the optimum reading area. If a predefined amount of movement is detected, the white illumination switches on. Scanning continues until a label is read or "maximum scan on time" is reached.

1. See the Product Reference Guide (PRG) for these and other programmable features
2. Controlled by Flash On Time and Flash Off Time. Use the PRG to program these options.

**SCAN MODE**



ENTER/EXIT PROGRAMMING MODE



◆ Scan Mode = Trigger Single



Scan Mode = Trigger  
Pulse Multiple



Scan Mode = Trigger  
Hold Multiple



Scan Mode = Flashing



Scan Mode = Always On



Scan Mode =  
Object Detection



## Pick Mode

Specifies the ability of the reader to decode labels only when they are close to the center of the aiming pattern, which is the area indicated by the two blue arrows. Pick Mode is a Decoding and Transmission process where bar codes that are not within the configurable distance from the center of the aiming pattern are not acknowledged or transmitted to the host. It is active only while the scanner is in Trigger Single mode. If the scanner switches to a different Read Mode, Pick Mode is automatically disabled.



**This feature is not compatible with Multiple Labels Reading in a Volume. See the PRG for more information.**

### NOTE

PICK MODE
 ENTER/EXIT PROGRAMMING MODE
 ◆ Pick Mode = Disable
 Pick Mode = Enable

## Multiple Label Reading

The reader offers a number of options for multiple label reading. See the PRG or software configuration tool for descriptions of these features and programming labels.

# Technical Features

## Heron™ HD3430

Item	Description
<b>Electrical Features</b>	
Power Supply RS-232 interface	5 Vdc ± 5%
Consumption:	Max operating current @ 5V: <500 mA Typical operating (changing colors) current @ 5V < 300 mA
Max. Scan Rate	60 frames/sec
Reading Indicators	Side and Top Illumination, Good Read Spot, Beep or Jingle
<b>Optical Features</b>	
Optical Format	1/3-inch
Active Imager Size	4.51 mm (H) x 2.88 mm (V)
Active Pixels	752 H x 480 V
Illumination System	LED source White emission (wavelength = 400-750 nm) IEC 62471 - EXEMPT RISK GROUP
Aiming System	Laser source Red emission (wavelength = 630-680 nm) Pulsed source: maximum lamp duration 15ms, repetition rate 16.6 ms Maximum emitted power: 1 mW IEC 60825 - CLASS 2 LASER PRODUCT
Tilt Tolerance	Up to ± 360°
Pitch Tolerance	± 65°
Skew Tolerance	± 60°
Field of View	40° H x 26° V
DOF Depth of Field (Typical)	Code 39: 5 mil, 35 mm - 200 mm (1.4" - 7.9") Code 39: 20 mil, FOV ltd - 400 mm (FOV ltd - 15.7") EAN13: 13 mil, 30 mm - 400 mm (1.2" - 15.8") DataMatrix: 15 mil, 20 mm - 250 mm (0.8" - 9.8")
Max. Resolution	Code 39, 3 mil, at 105 mm (4.1")
PCS (Datalogic Test Chart)	minimum 15%

Item	Description
<b>Environmental Features</b>	
Working Temperature	0 °C to +50 °C (+32° to +122 °F)
Storage Temperature	-20 °C to +70 °C (-4° to +158 °F)
Humidity	90% non condensing
Drop Resistance	IEC 68-2-32 Test ED 1.5 m (5 ft)
ESD Protection	16 KV
Protection Class	IP40
Weight (without cable)	approx. 150 g (5.3 oz)
Cable Length	Refer to <a href="http://www.datalogic.com">www.datalogic.com</a>
<b>Decode Capability</b>	
<b>1D Bar Codes</b> UPC/EAN/JAN (A, E, 13, 8); UPC/EAN/JAN (including P2 /P5); UPC/EAN/JAN (including; ISBN / Bookland & ISSN); UPC/EAN Coupons; Code 39 (including full ASCII); Code 39 Trioptic; Code39 CIP (French Pharmaceutical); LOGMARS (Code 39 w/ standard check digit enabled); Danish PPT; Code 32 (Italian Pharmacode 39); Code 128; Code 128 ISBT; Interleaved 2 of 5; Standard 2 of 5; Interleaved 2 of 5 CIP (HR); Industrial 2 of 5; Discrete 2 of 5; Matrix 2 of 5; IATA 2of5 Air cargo code; Code 11; Codabar; Codabar (NW7); ABC Codabar; EAN 128; Code 93; MSI; PZN; Plessey; Anker Plessey; GS1 DataBar Omnidirectional; GS1 DataBar Limited; GS1 DataBar Expanded; GS1 DataBar Truncated; DATABAR Expanded Coupon.	
<b>2D / Stacked Codes</b> The Heron HD34XX scanner is capable of decoding the following symbologies using multiple frames (i.e. Multi-Frame Decoding):  Datamatrix; Inverse Datamatrix; Datamatrix is configurable for the following parameters; Normal or Inverted; Square or Rectangular Style; Data length (1 - 3600 characters); Maxicode; QR Codes (QR, Micro QR and Multiple QR Codes); Aztec; Postal Codes - (Australian Post; Japanese Post; KIX Post; Planet Code; Postnet; Royal Mail Code (RM45CC); Intelligent Mail Barcode (IMB); Sweden Post; Portugal Post); LaPoste A/R 39; PDF-417; MacroPDF; Micro PDF417; GS1 Composites (1 - 12); French CIP13 <sup>a</sup> ; GS1 DataBar Stacked; GS1 DataBar Stacked Omnidirectional; GS1 DataBar Expanded Stacked; GS1 Databar Composites; Chinese Sensible Code; Inverted 2D codes <sup>b</sup> . <sup>a</sup> It is acceptable to handle this with ULE <sup>b</sup> The SW can apply the Normal/Reverse Decoding Control to the following symbologies: Datamatrix, QR, Micro QR, Aztec and Chinese Sensible Code.	

## LED and Beeper Indications

The imager's beeper sounds and its illumination flashes or changes color to indicate various functions or errors on the reader. A 'Green Spot' also lights to indicate a good read. The tables below list these indications. Reference the PRG for a more detailed list.

Indication	LED	Beeper
Power-up	Upper LED flashes/blinks on power-up, however, this may be too rapid to view. With a USB interface, the LED blinks until enumeration with the host is completed.	Imager beeps four times at highest frequency and volume upon power-up.
Good Read	Upper green LED comes on for programmed time (default). LED behavior for this indication is configurable using Aladdin utility.	One beep at current frequency, volume, mono/bi-tonal setting upon a successful label scan. It is also possible to upload custom jingles with Aladdin.
ROM Failure	200ms on / 200ms off	Imager sounds one error beep at highest volume for 200 mS.
Limited Scanning Label Read	N/A	Imager 'chirps' six times at the highest frequency and current volume.
Imager Disabled	The LED blinks continuously 100mS on / 900 mS off	N/A

# Troubleshooting

Problem	Possible Cause	Possible Solutions
Nothing happens when the scan button is pulled.	No power to the imager.	Check system power. Ensure power supply is connected.
	Interface or power cables are loose.	Ensure all cable connections are secure.
LED comes on, but bar code does not decode.	Imager not programmed for correct bar code type.	Ensure imager is programmed to read the type of bar code scanned. Refer to the PRG for more information.
	Bar code label is unreadable.	Check the label to ensure it is not defaced. Try scanning another bar code type.
	Distance between imager and bar code is incorrect.	Move imager closer to or further from the bar code.
Bar code is decoded but not transmitted to the host.	Imager not programmed for the correct host type.	Scan the appropriate host type barcode. Refer to the PRG for more information.



**For detailed troubleshooting, refer to the PRG (Product Reference Guide)**

**NOTE**

## Datalogic Limited Factory Warranty

### Warranty Coverage

Datalogic warrants to Customer that Datalogic's products will be free from defects in materials and workmanship for a period of five (5) years from product shipment. Datalogic ("Datalogic") hardware products are warranted against defects in material and workmanship under normal and proper use. The liability of Datalogic under this warranty is limited to furnishing the labor and parts necessary to remedy any defect covered by this warranty and restore the product to its normal operating condition. Repair or replacement of product during the warranty does not extend the original warranty term. Products are sold on the basis of specifications applicable at the time of manufacture and Datalogic has no obligation to modify or update products once sold.

If Datalogic determines that a product has defects in material or workmanship, Datalogic shall, at its sole option repair or replace the product without additional charge for parts and labor, or credit or refund the defective products duly returned to Datalogic. To perform repairs, Datalogic may use new or reconditioned parts, components, subassemblies or products that have been tested as meeting applicable specifications for equivalent new material and products. Customer will allow Datalogic to scrap all parts removed from the repaired product. The warranty period shall extend from the date of shipment from Datalogic for the duration published by Datalogic for the product at the time of purchase (Warranty period). Datalogic warrants repaired hardware devices against defects in workmanship and materials on the repaired assembly for a 90 day period starting from the date of shipment of the repaired product from Datalogic or until the expiration of the original warranty period, whichever is longer. Datalogic does not guarantee, and it is not responsible for, the maintenance of, damage to, or loss of configurations, data, and applications on the repaired units and at its sole discretion can return the units in the "factory default" configuration or with any software or firmware update available at the time of the repair (other than the firmware or software installed during the manufacture of the product). Customer accepts responsibility to maintain a back up copy of its software and data.

### Warranty Claims Process

In order to obtain service under the Factory Warranty, Customer must notify Datalogic of the claimed defect before the expiration of the applicable Warranty period and obtain from Datalogic a return authorization number (RMA) for return of the product to a designated Datalogic service center. If Datalogic determines Customer's claim is valid, Datalogic will repair or replace product without additional charge for parts and labor. Customer shall be responsible for packaging and shipping the product to the designated Datalogic service center, with shipping charges prepaid. Datalogic shall pay for the return of the product to Customer if the shipment is to a location within the country in which the Datalogic service center is located. Customer shall be responsible for paying all shipping charges, duties, taxes, and any other charges for products returned to any other locations. Failure to follow the applicable RMA policy, may result in a processing fee. Customer shall be responsible for return shipment expenses for products which Datalogic, at its sole discretion, determines are not defective or eligible for warranty repair.

### Warranty Exclusions

The Datalogic Factory Warranty shall not apply to:

- (i) any product which has been damaged, modified, altered, repaired or upgraded by other than Datalogic service personnel or its authorized representatives;



- (ii) any claimed defect, failure or damage which Datalogic determines was caused by faulty operations, improper use, abuse, misuse, wear and tear, negligence, improper storage or use of parts or accessories not approved or supplied by Datalogic;
- (iii) any claimed defect or damage caused by the use of product with any other instrument, equipment or apparatus;
- (iv) any claimed defect or damage caused by the failure to provide proper maintenance, including but not limited to cleaning the upper window in accordance with product manual;
- (v) any defect or damage caused by natural or man-made disaster such as but not limited to fire, water damage, floods, other natural disasters, vandalism or abusive events that would cause internal and external component damage or destruction of the whole unit, consumable items;
- (vi) any damage or malfunctioning caused by non-restoring action as for example firmware or software upgrades, software or hardware reconfigurations etc.;
- (vii) the replacement of upper window/cartridge due to scratching, stains or other degradation and/or
- (viii) any consumable or equivalent (e.g., cables, power supply, batteries, keypads, touch screen, triggers etc.).

### **No Assignment**

Customer may not assign or otherwise transfer its rights or obligations under this warranty except to a purchaser or transferee of product. No attempted assignment or transfer in violation of this provision shall be valid or binding upon Datalogic.

DATALOGIC'S LIMITED WARRANTY IS IN LIEU OF ALL OTHER WARRANTIES, EXPRESS OR IMPLIED, ORAL OR WRITTEN, STATUTORY OR OTHERWISE, INCLUDING, WITHOUT LIMITATION, ANY IMPLIED WARRANTIES OF MERCHANTABILITY, FITNESS FOR A PARTICULAR PURPOSE, OR NONINFRINGEMENT. DATALOGIC SHALL NOT BE LIABLE FOR ANY DAMAGES SUSTAINED BY CUSTOMER ARISING FROM DELAYS IN THE REPLACEMENT OR REPAIR OF PRODUCTS UNDER THE ABOVE. THE REMEDY SET FORTH IN THIS WARRANTY STATEMENT IS THE CUSTOMER'S SOLE AND EXCLUSIVE REMEDY FOR WARRANTY CLAIMS. UNDER NO CIRCUMSTANCES WILL DATALOGIC BE LIABLE TO CUSTOMER OR ANY THIRD PARTY FOR ANY LOST PROFITS, OR ANY INCIDENTAL, CONSEQUENTIAL IN-DIRECT, SPECIAL OR CONTINGENT DAMAGES REGARDLESS OF WHETHER DATALOGIC HAD ADVANCE NOTICE OF THE POSSIBILITY OF SUCH DAMAGES.

### **Risk of Loss**

Customer shall bear risk of loss or damage for product in transit to Datalogic. Datalogic shall assume risk of loss or damage for product in Datalogic's possession. In the absence of specific written instructions for the return of product to Customer, Datalogic will select the carrier, but Datalogic shall not thereby assume any liability in connection with the return shipment.

## Ergonomic Recommendations



### CAUTION

In order to avoid or minimize the potential risk of ergonomic injury follow the recommendations below. Consult with your local Health & Safety Manager to ensure that you are adhering to your company's safety programs to prevent employee injury.

- Reduce or eliminate repetitive motion
- Maintain a natural position
- Reduce or eliminate excessive force
- Keep objects that are used frequently within easy reach
- Perform tasks at correct heights
- Reduce or eliminate vibration
- Reduce or eliminate direct pressure
- Provide adjustable workstations
- Provide adequate clearance
- Provide a suitable working environment
- Improve work procedures.

## Support Through the Website

Datalogic provides several services as well as technical support through its website.

Log on to [www.datalogic.com](http://www.datalogic.com) and click on the **SUPPORT > General Duty Handheld Scanners** category link. From this page you can select your product model from the dropdown list which gives you access to:

**Downloads** including Data Sheets, Manuals, Software & Utilities, and Drawings;

**Repair Program** for On-Line Return Material Authorizations (RMAs) plus Repair Center contact information;

**Service Program** containing details about Maintenance Agreements;

**Technical Support** through email or phone.

## Cleaning

Exterior surfaces and scan windows exposed to spills, smudges or debris require periodic cleaning to ensure best performance during scanning.

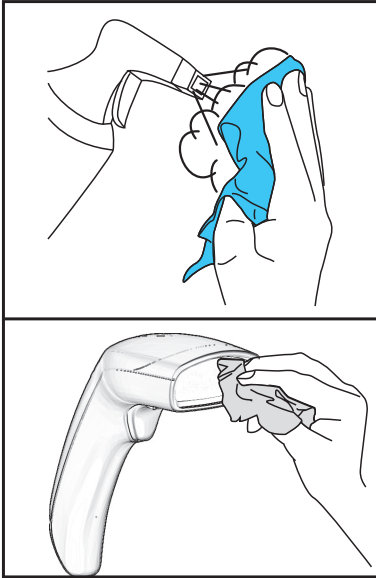

Use a soft, dry cloth to clean the product. If the product is very soiled, clean it with a soft cloth moistened with a diluted non-aggressive cleaning solution or diluted ethyl alcohol.



**CAUTION**

**Do not use abrasive or aggressive cleansing agents or abrasive pads to clean scan windows or plastics.**

**Do not spray or pour liquids directly onto the unit.**

# Stand Dimensions

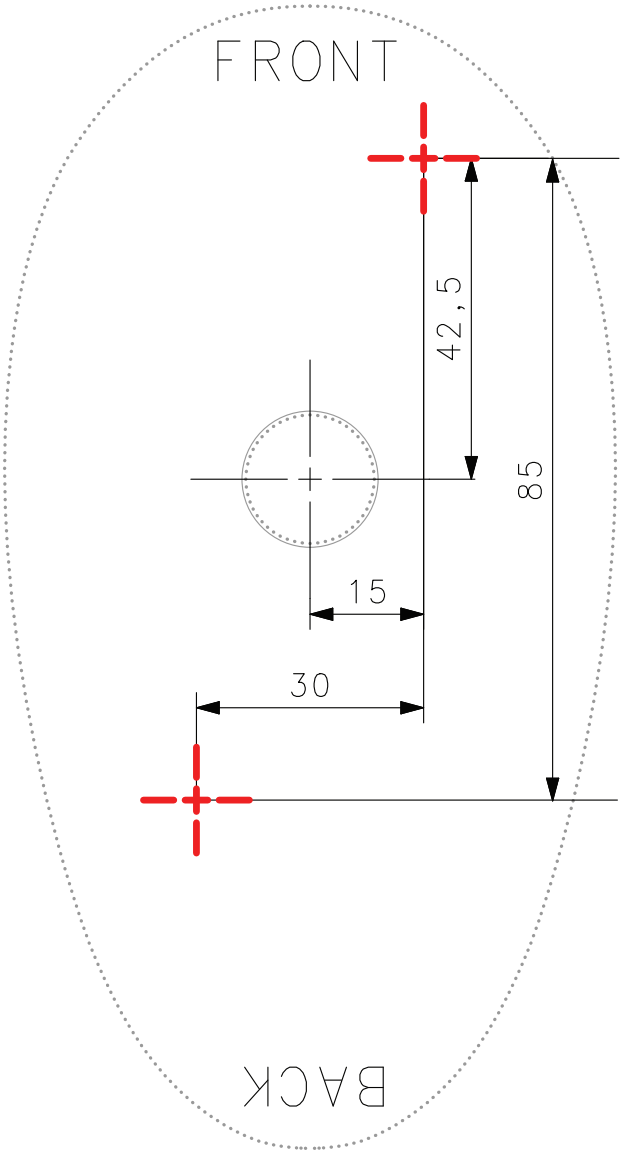

# Stand Base Plate Template



# NOTES





[www.datalogic.com](http://www.datalogic.com)

©2015-2017 Datalogic S.p.A. and/or its affiliates. All rights reserved. Datalogic and the Datalogic logo are registered trademarks of Datalogic S.p.A. in many countries, including the U.S.A. and the E.U. Heron is a trademark of Datalogic S.p.A. and/or its affiliates, registered in the U.S.

**Datalogic USA, Inc.**

959 Terry Street | Eugene, OR 97402 | USA  
Telephone: (541) 683-5700 | Fax: (541) 345-7140



820096114

(Rev D

June 2017